

Double Leaf PLANE Line RC2 Burglar Resistant Security Door

Burglar Protection **RC2** **tested acc. to EN 1627**

Optional Audited Additional Functions

- Sound Insulation	up to R_{w,P} 54dB	tested acc. to EN ISO 10140-2
- Bullet Resistance	FB4/FB6-NS	tested acc. to EN 1522
- Air Tight	bis Klasse 4	tested acc. to EN 1026
- Rain- and Fire-Water Tight	Klasse 6A	tested acc. to EN 1027
- Wind load Resistance	bis Klasse C5	tested acc. to EN 12211
- Blast Resistance	bis 20 kPa	tested acc. to EN 13124-1
- Explosion Protection	bis Zone 1/21	acc. to EN 1127-1 or ATEX 2014/34/EU
- Stainless Steel		

Range of Dimension

Width from 1000 mm to 3000 mm
Height from 500 mm to 3000 mm

Technical Specification and Tender Text

Product:	PL2 double leaf security door brand Buchele tested acc. to EN 1627
Door Type:	PLANE Line PL 2 BASIC
Resistance Class:	RC2
Structural Opening: x mm
Door Leaf:	Double-walled, planar 70 mm thick steel door leaf without hinge embossing, three sides rebated with thick rebate. Without bottom stop. Special insulating inserts fully laid-in and glued. Passive leaf with multi-chamber sealing profile in the middle rebate. Securing pin screwed in door leaf rebate.
Threshold:	Floor bracket as separation sill. Surface galvanized and welded to the frame.
Frame:	3-sided circumferential rebated corner frame High-quality multi chamber sealing profile adjustable fixed in the three-sided groove.
Hinges:	Three-part, height adjustable construction hinges with hinge pin retention and ball bearing spacer ring for smooth door movement.
Fitting:	Active leaf with 2-point security mortise lock with latch lever function acc. to EN 12209 (prepared for installation of a profile cylinder lock, provided by customer). Security door handle set in acc. to EN 1906 fixed pivoted synthetic material black in U-shape with rounded long-plate. Passive leaf with concealed shoot bolt lock.
Surface:	Door leaf and frame galvanized und primed with 2K-PUR primer (Very High Solid) similar RAL 7035.

Alternative: PLANE Line PL 2 PREMIUM with flush mounted optics

- Frame:** 3-sided circumferential rebated PLANE Line special corner frame for flush mounted optics on hinge side.
High-quality multi-chamber sealing profile adjustable fixed in the three-sided groove.
- Hinges:** Object hinges type VB-3D 160 adjustable in three dimensions.
Fixture element with slide bearings inside for smooth door movement.

Alternative: PLANE Line PL 2 SUPERIOR with flush mounted optics

- Frame:** 3-sided circumferential rebated PLANE Line special corner frame for flush mounted optics on hinge side.
High-quality multi-chamber sealing profile adjustable fixed in the three-sided groove.
- Hinges:** Concealed hinge system adjustable in three dimensions.

Supplementary Equipment

- Glazing:** P4A single or insulating glazing fixed with profiled glazing bars.
Minimum border 125 mm on side and top, base 300 mm.
- Ventilation Grill:** Burglar resistant and poke proof ventilation grill.
With galvanized bird screen 10x10 mm inside.
- Stainless Steel:** Material 1.4301 (V2A) or 1.4404 (V4A),
Surface mill finish or brushed.
- BUCHELE DELUXE:** The exclusive surface coating.

BASIC - Version

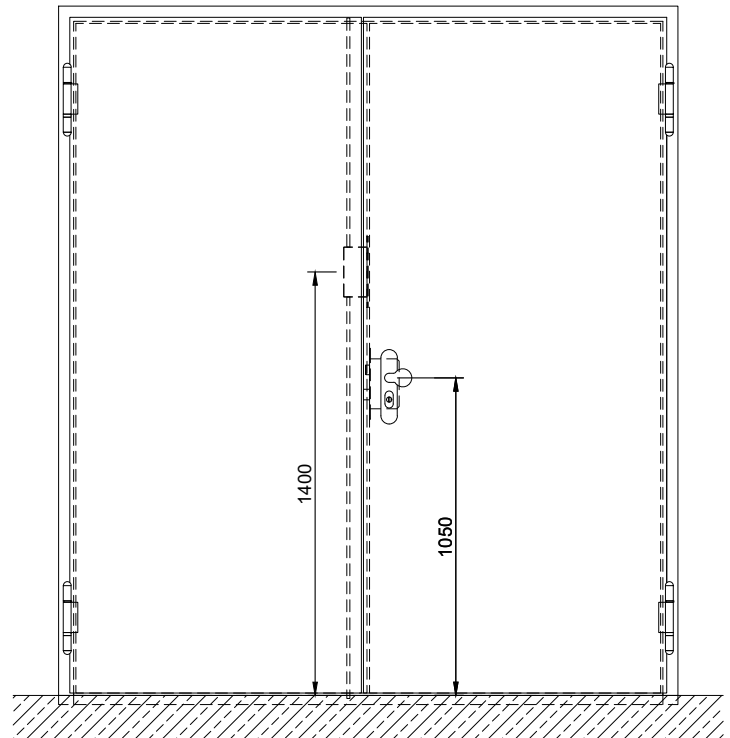
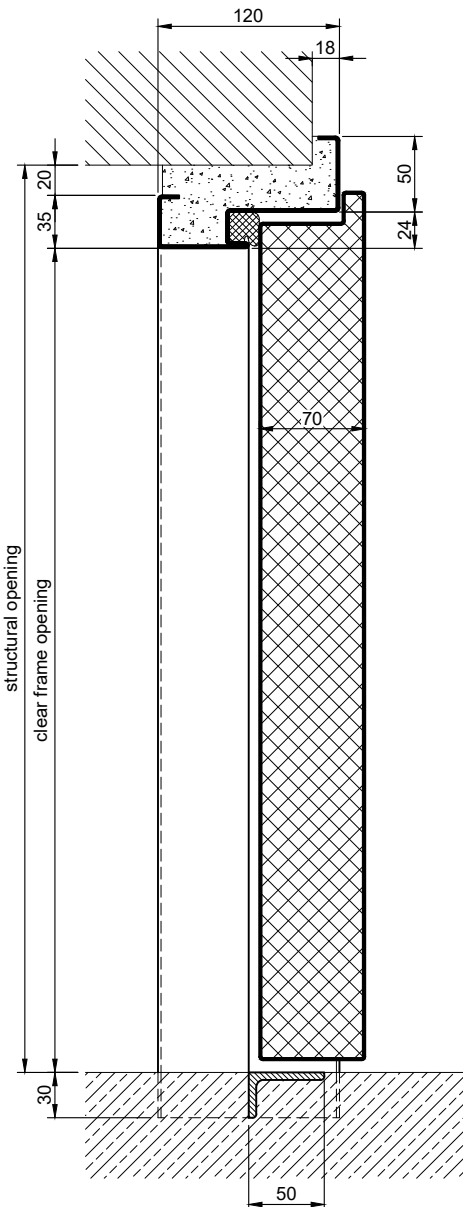
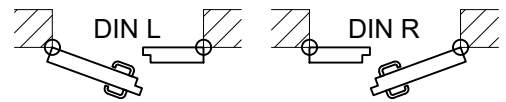
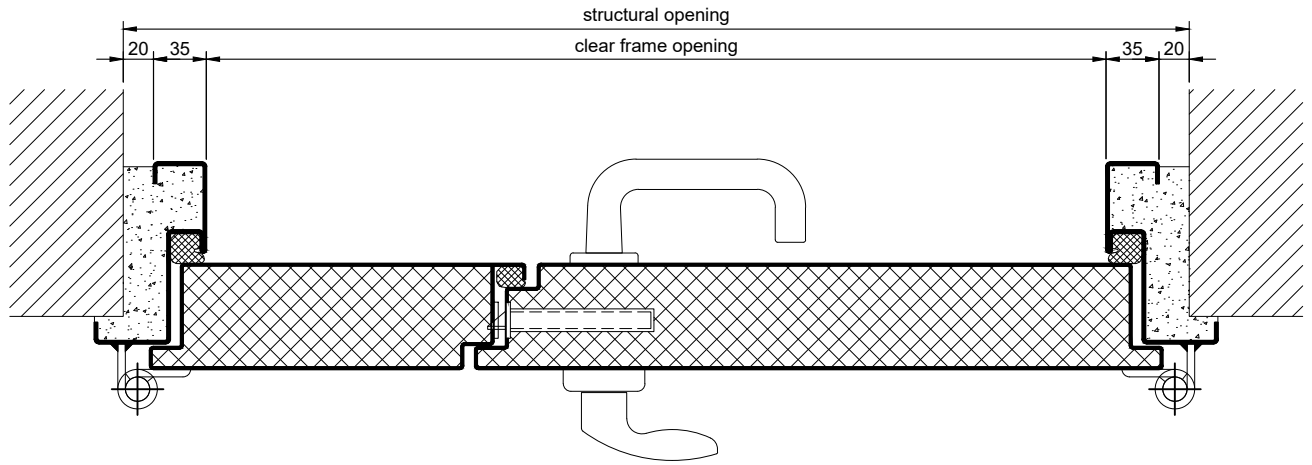

3.10.1_PLANE LINE PL 2 RC2_EN

technical modifications reserved - edition 06/2024

PREMIUM - Version

object hinges VB-3D

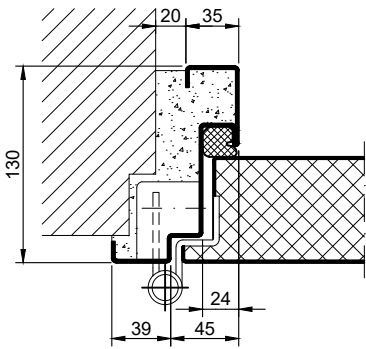

construction hinges

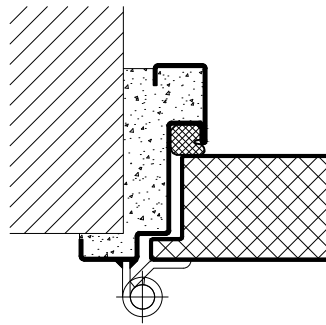

SUPERIOR - Version

concealed hinges

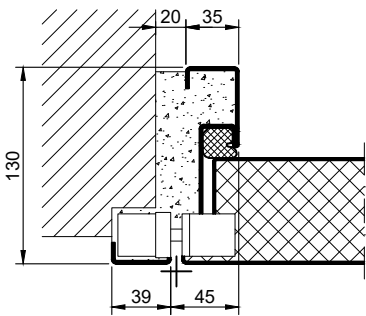

Options

glazing

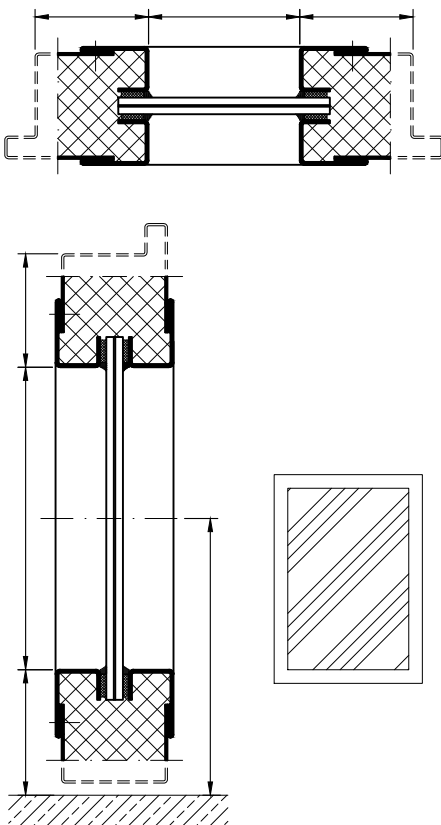

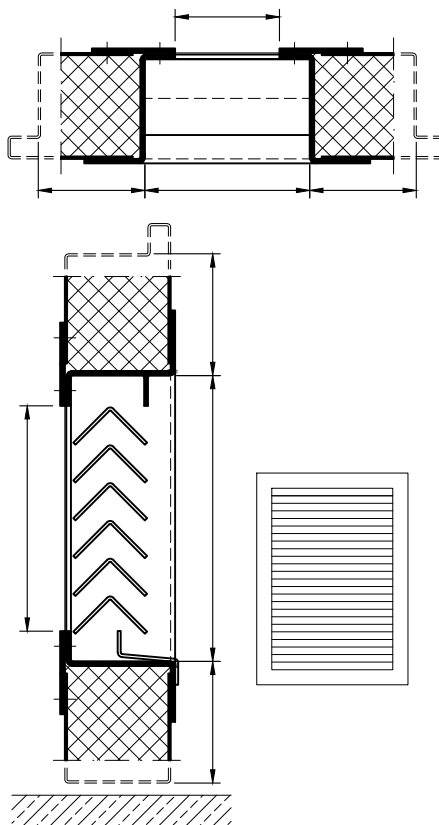

ventilation grill

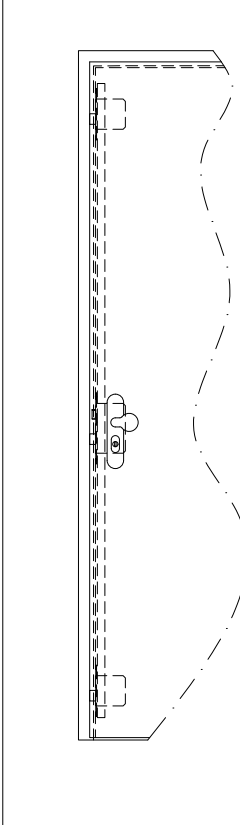

3-point locking system

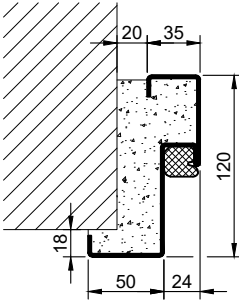
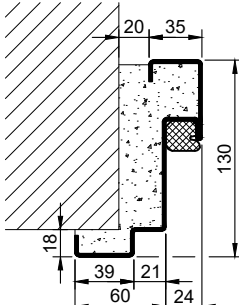
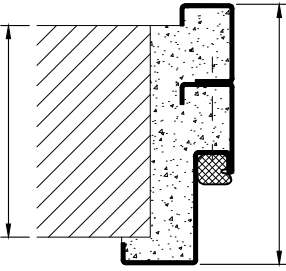
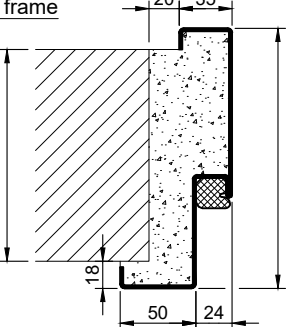
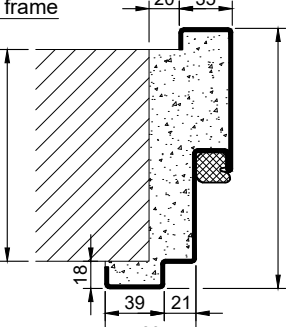
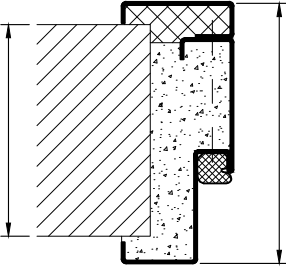
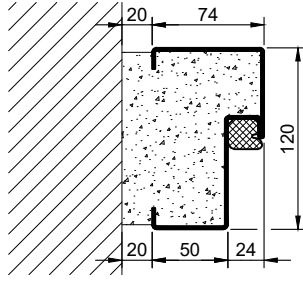

3.10.1_PLANE LINE PL 2 RC2_EN

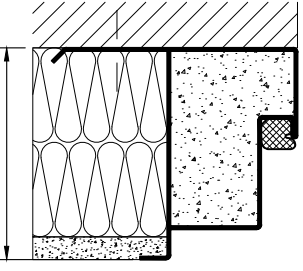
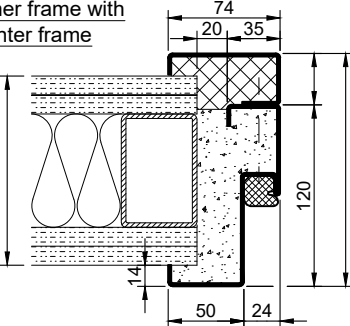
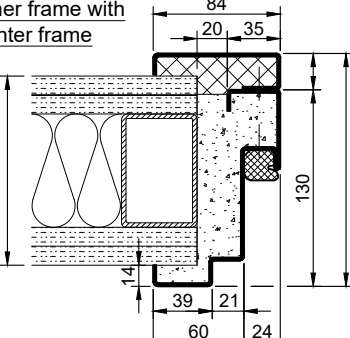
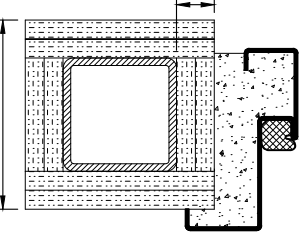
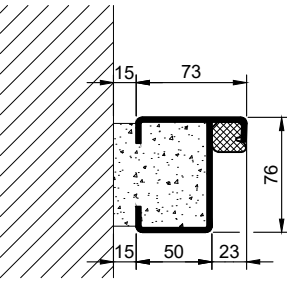
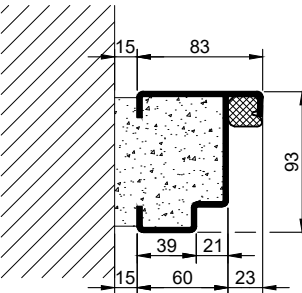
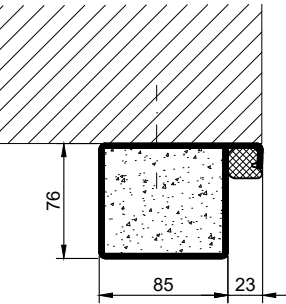
Frames BASIC	Frames PREMIUM / SUPERIOR	Variants (illustration BASIC)
<p>corner frame</p> 	<p>corner frame</p> 	<p>corner frame with additional frame</p> 
<p>encasing frame</p> 	<p>encasing frame</p> 	<p>encasing frame with counter frame</p> 
<p>block frame</p> 	<p>block frame</p> 	<p>juted block frame</p> 
<p>corner frame with counter frame</p> 	<p>corner frame with counter frame</p> 	<p>corner frame at support / pillar</p> 
<p>profile block frame</p> 	<p>profile block frame</p> 	<p>pre-wall frame</p> 

3.10.1_PLANE LINE PL 2 RC2_EN

technical modifications reserved - edition 06/2024

Thresholds

separation sill

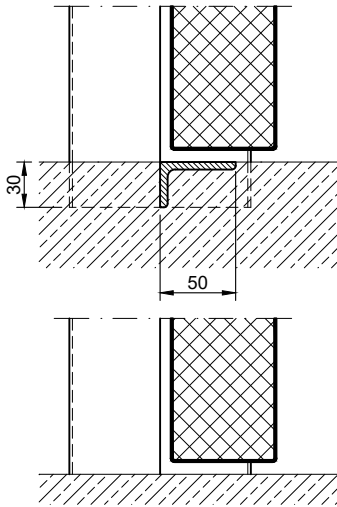

drop seal

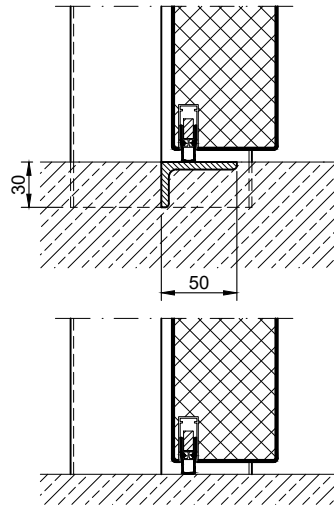

stop sill with seal

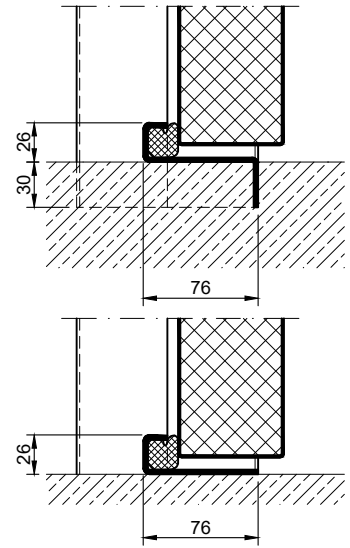

stop sill with seal

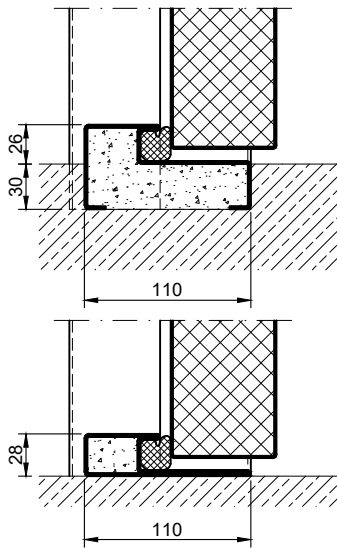

stop sill without seal

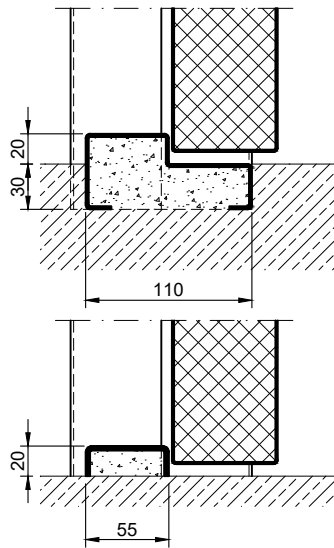

stop sill with drop seal

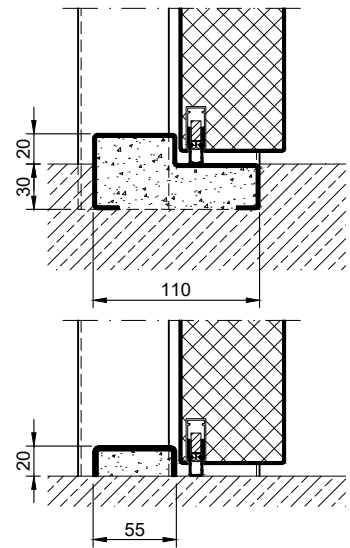

separation sill with half-round strip

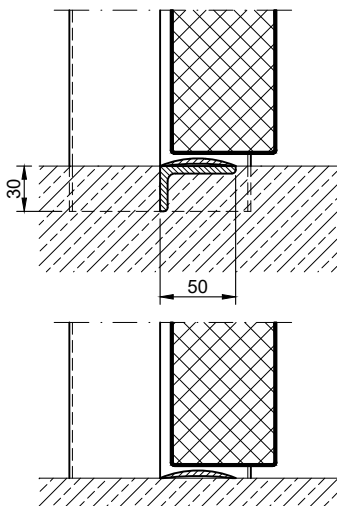

full sill

