

Double Leaf EI₂90 Fire Retardant Steel Sliding Gate

Fire Protection **EI₂90-S_aC2** **tested acc. to EN 13241 and EN 16034**

Optional Audited Additional Functions

- Smoke Control **S200**
- Glazing
- Wicket Door
- Stainless Steel

Range of Dimension

Width from 2000 mm up to 8500 mm
Height from 2000 mm up to 6000 mm

Technical Description and Tender Text

Product: **EI₂90 double leaf fire retardant steel sliding gate brand Buchele tested acc. to EN 13241 and EN 16034**

Door Type: **T90-2 ST**

Structural Opening: **.... x mm**

Door Leaf: Made of basic elements (number according to the specific opening width), 67 mm thick, folded out of 1,0 mm sheet metal.
The edge overlap is at least 150 mm at the side, at least 75 mm at the top (for low lintel at least 85 mm).

Frame: 3-sided pressed labyrinth seal with 2 pieces of gate guiding systems placed outside the passage area.

Fitting: The door leaf has a shell type handle on both sides. The running gear consists of one double pair of ball bearing mounted rollers per element, running in a helm rail.
The gate closes automatically by a counterweight in the sheet metal casing. The door leaf is fitted with a radial damper to ensure an equal closing movement and a hydraulic damper to reduce the impact in the in- and out-going direction.

Surface: Door leaf and frame galvanized. Priming possible at an extra charge.

Mounting: Delivery and professional mounting.

Installation: masonry ≥ 240 mm
concrete ≥ 140 mm
areated concrete ≥ 240 mm

Supplementary Equipment

Smoke Control:	With buffer seals in the run-in areas and sliding seals in the lintel and floor area.
Glazing:	F90 fire protective glazing. Minimum border each panel field 190 mm on side and top, base 1150 mm, but max. 450 x 1100 mm.
Wicket Door:	Size max. 1000 x 2000 mm (without threshold). A wicket door may only be installed from a gate width of 1500 mm and a gate height of 2100 mm.
Stainless Steel:	Material 1.4301 (V2A) or 1.4404 (V4A), Surface mill finish or brushed.

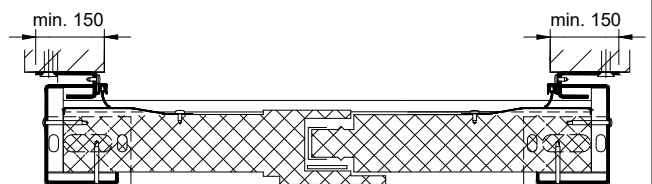
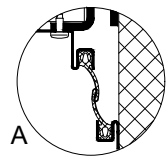
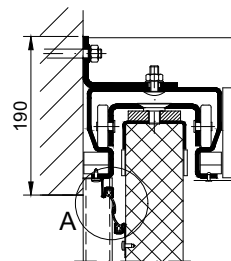
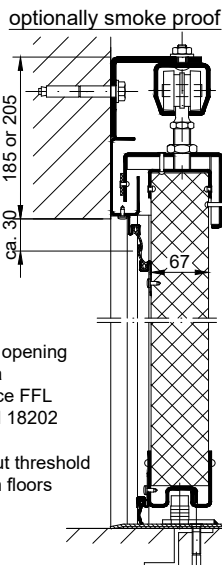
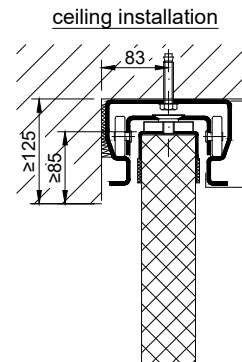
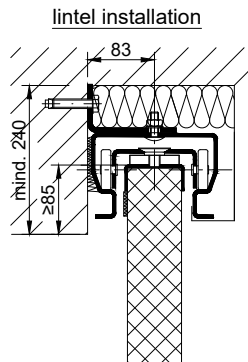
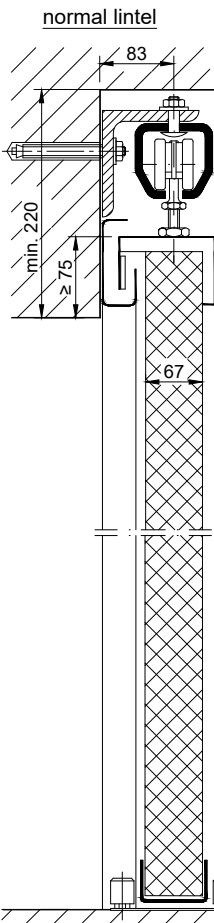
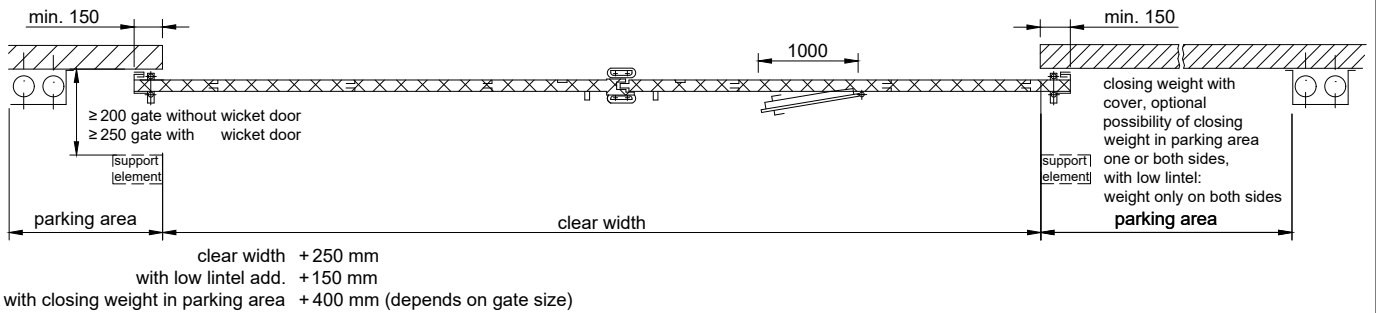
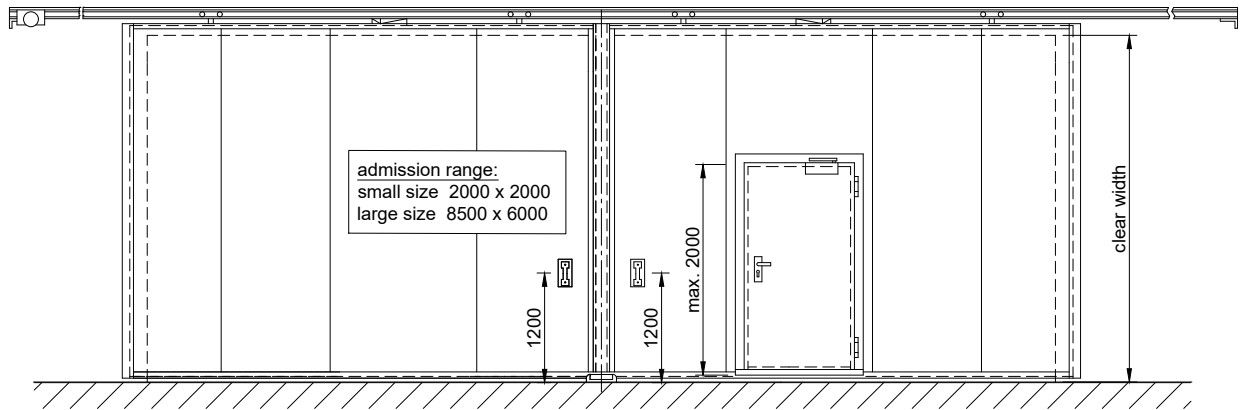

Threshold in the opening and parking area planarity tolerance FFL according to DIN 18202 Table 3, Line 4. Optionally without threshold for even, smooth floors without grooves.